

3.1 Strainers

3.1.1 Angular filters

page

angular filter, angular body, weld ends, DIN (701S).....	3.1.1-1
angular filter, with heating jacket, weld ends, DIN (701H).....	3.1.1-1
angular filter, weld ends, inch OD (701Z).....	3.1.1-3
angular filter, male/male, DIN (701).....	3.1.1-3
strainer for angular filter, 1,5 mm round hole perforation (701A).....	3.1.1-5
strainer for angular filter, individual round hole perforation.....	3.1.1-5
strainer for angular filter, with gaze inside (701B).....	3.1.1-5
strainer for angular filter, slotted tube type (R-design: inside->outside) (710D).....	3.1.1-5

3.1.2 Strainers • Passage filters

page

Passage filter, betw. flanges, DIN (702).....	3.1.2-1
Strainer for passage filter, 1.5 mm round hole perfor. (702A).....	3.1.2-1
Strainer for passage filter, with gauze inside (702B).....	3.1.2-1

3.1.3 Strainers • Dirt collecting filter

page

Dirt collecting filter, weld ends, DIN (703).....	3.1.3-1
Dirt collecting filter, weld ends, inch OD (703Z).....	3.1.3-1
Dirt collecting filter, male/male, DIN (703).....	3.1.3-1
Strainer for dirt collecting filter, 1.5 mm round hole perfor. (703A).....	3.1.3-1
Strainer for dirt collecting filter, gauze (703B).....	3.1.3-3

angular filter, angular body, weld ends, DIN (70IS)

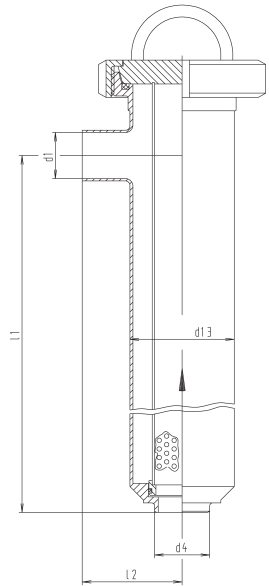

DN	d1	d4	d13	l1	l2	weight (kg)
25	26	31	70	316	68	-
32	32	37	70	316	68	-
40	38	43	104	329	93	-
50	50	55	104	329	92	-
65	66	72	104	314	90	-
80	81	87	129	548	135	-
100	100	106	154	546	130	-
125	125	132	180	554	164	-
150	150	155	206	613	203	-

angular filter, with heating jacket, weld ends, DIN (70IH)

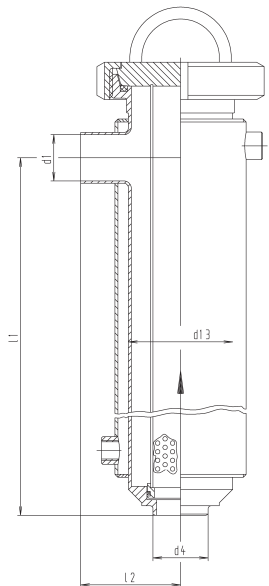

DN	d1	d4	d13	l1	l2	weight (kg)
25	26	31	70	316	68	-
32	32	37	70	316	68	-
40	38	43	104	329	93	-
50	50	55	104	329	92	-
65	66	72	104	314	90	-
80	81	87	129	548	135	-
100	100	106	154	546	130	-
125	125	132	180	554	164	-
150	150	155	206	613	203	-

angular filter, angular body, weld ends, DIN (70IS)

DN	304 polished Ident number	304 matt Ident number	316 L polished Ident number	316 L matt Ident number
25	○ 171.08.110.0003	○ 171.08.210.0003	○ 171.08.120.0003	○ 171.08.220.0003
32	○ 171.09.110.0003	○ 171.09.210.0003	○ 171.09.120.0003	○ 171.09.220.0003
40	○ 171.10.110.0003	○ 171.10.210.0003	○ 171.10.120.0003	○ 171.10.220.0003
50	○ 171.11.110.0003	○ 171.11.210.0003	○ 171.11.120.0003	○ 171.11.220.0003
65	○ 171.12.110.0003	○ 171.12.210.0003	○ 171.12.120.0003	○ 171.12.220.0003
80	○ 171.14.110.0003	○ 171.14.210.0003	○ 171.14.120.0003	○ 171.14.220.0003
100	● 171.15.110.0003	○ 171.15.210.0003	○ 171.15.120.0003	○ 171.15.220.0003
125	○ 171.16.110.0003	○ 171.16.210.0003	○ 171.16.120.0003	○ 171.16.220.0003
150	○ 171.17.110.0003	○ 171.17.210.0003	○ 171.17.120.0003	○ 171.17.220.0003

standard gasket NBR considered, other material on demand

angular filter, with heating jacket, weld ends, DIN (70IH)

DN	304 polished Ident number	304 matt Ident number	316 L polished Ident number	316 L matt Ident number
25	○ 171.08.110.0004	○ 171.08.210.0004	○ 171.08.120.0004	○ 171.08.220.0004
32	○ 171.09.110.0004	○ 171.09.210.0004	○ 171.09.120.0004	○ 171.09.220.0004
40	○ 171.10.110.0004	○ 171.10.210.0004	○ 171.10.120.0004	○ 171.10.220.0004
50	○ 171.11.110.0004	○ 171.11.210.0004	○ 171.11.120.0004	○ 171.11.220.0004
65	○ 171.12.110.0004	○ 171.12.210.0004	○ 171.12.120.0004	○ 171.12.220.0004
80	○ 171.14.110.0004	○ 171.14.210.0004	○ 171.14.120.0004	○ 171.14.220.0004
100	○ 171.15.110.0004	○ 171.15.210.0004	○ 171.15.120.0004	○ 171.15.220.0004
125	○ 171.16.110.0004	○ 171.16.210.0004	○ 171.16.120.0004	○ 171.16.220.0004
150	○ 171.17.110.0004	○ 171.17.210.0004	○ 171.17.120.0004	○ 171.17.220.0004

standard gasket NBR considered, other material on demand

angular filter, weld ends, inch OD (701Z)

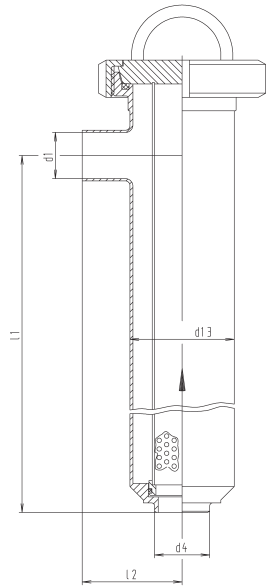

DN	d1	d4	d13	l1	l2	weight (kg)
1"	22.1	25.4	70	316	68	-
1½"	34.8	38.1	104	329	93	-
2"	47.5	50.8	104	329	92	-
2½"	60.2	63.5	104	314	90	-
3"	72.9	76.2	129	548	135	-
4"	97.4	101.6	154	546	130	-

angular filter, male/male, DIN (701)

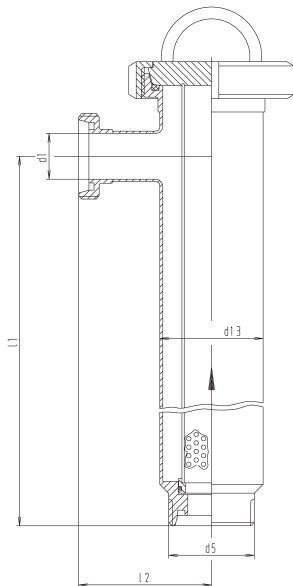

DN	d1	d5	d13	l1	l2	weight (kg)
25	26	52x1/6"	70	327	90	3,300
32	32	58x1/6"	70	327	90	3,400
40	38	65x1/6"	104	340	115	6,190
50	50	78x1/6"	104	340	115	6,200
65	66	95x1/6"	104	325	115	6,500
80	81	110x1/4"	129	560	160	11,800
100	100	130x1/4"	154	560	160	16,280
125	125	160x1/4"	180	560	200	21,450
150	150	190x1/4"	206	620	240	-

angular filter, weld ends, inch OD (701Z)

DN	304 polished Ident number	304 matt Ident number	316 L polished Ident number	316 L matt Ident number
1"	○ 171.08.110.0013	○ 171.08.210.0013	○ 171.08.120.0013	○ 171.08.220.0013
1½"	○ 171.10.110.0013	○ 171.10.210.0013	○ 171.10.120.0013	○ 171.10.220.0013
2"	○ 171.11.110.0013	○ 171.11.210.0013	○ 171.11.120.0013	○ 171.11.220.0013
2½"	○ 171.12.110.0013	○ 171.12.210.0013	○ 171.12.120.0013	○ 171.12.220.0013
3"	○ 171.13.110.0013	○ 171.13.210.0013	○ 171.13.120.0013	○ 171.13.220.0013
4"	○ 171.15.110.0013	○ 171.15.210.0013	○ 171.15.120.0013	○ 171.15.220.0013

standard gasket NBR considered, other material on demand

angular filter, male/male, DIN (701)

DN	304 polished Ident number	304 matt Ident number	316 L polished Ident number	316 L matt Ident number
25	● 171.08.110.0000	○ 171.08.210.0000	○ 171.08.120.0000	○ 171.08.220.0000
32	● 171.09.110.0000	○ 171.09.210.0000	○ 171.09.120.0000	○ 171.09.220.0000
40	● 171.10.110.0000	○ 171.10.210.0000	○ 171.10.120.0000	○ 171.10.220.0000
50	● 171.11.110.0000	○ 171.11.210.0000	○ 171.11.120.0000	○ 171.11.220.0000
65	● 171.12.110.0000	● 171.12.210.0000	○ 171.12.120.0000	○ 171.12.220.0000
80	○ 171.14.110.0000	○ 171.14.210.0000	○ 171.14.120.0000	○ 171.14.220.0000
100	○ 171.15.110.0000	○ 171.15.210.0000	○ 171.15.120.0000	○ 171.15.220.0000
125	○ 171.16.110.0000	○ 171.16.210.0000	○ 171.16.120.0000	○ 171.16.220.0000
150	○ 171.17.110.0000	○ 171.17.210.0000	○ 171.17.120.0000	○ 171.17.220.0000

standard gasket NBR considered, other material on demand

strainer for angular filter, 1,5 mm round hole perforation (701A)

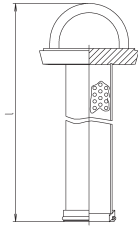

DN	l	weight (kg)
25-32 / 1"	422	0,970
40 - 65	479	2,310
1½"-2½"	479	2,310
80 / 3"	810	3,700
100 / 4"	793	5,400
125	837	-
150	928	-

strainer for angular filter, individual round hole perforation

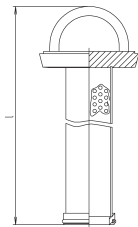

DN	l	weight (kg)
25-32 / 1"	422	-
40 - 65	479	-
1½"-2½"	479	-
80 / 3"	810	-
100 / 4"	793	-
125	837	-
150	928	-

strainer for angular filter, with gaze inside (701B)

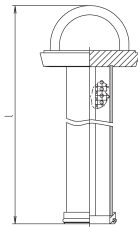

DN	l	weight (kg)
25-32 / 1"	422	1,170
40 - 65	479	2,510
1½"-2½"	479	2,510
80 / 3"	810	3,920
100 / 4"	793	5,620
125	837	-
150	928	-

strainer for angular filter, slotted tube type (R-design: inside->outside) (710D)

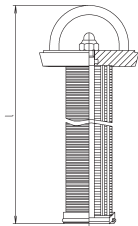

DN	l	weight (kg)
25-32 / 1"	422	-
40 - 65	479	-
1½"-2½"	479	-
80 / 3"	810	-
100 / 4"	793	-
125	837	-
150	928	-

t-pieces, short, DIN 11852 (for rubbing acc. DIN 11850 line 2) (311IN)

DN	304 polished Ident number	304 matt Ident number	316 L polished Ident number	316 L matt Ident number
25-32 / 1"	171.08.110.0001	171.08.210.0001	171.08.120.0001	171.08.220.0001
40 - 65	171.10.110.0001	171.10.210.0001	171.10.120.0001	171.10.220.0001
1½"-2½"	171.10.110.0001	171.10.210.0001	171.10.120.0001	171.10.220.0001
80 / 3"	171.14.110.0001	171.14.210.0001	171.14.120.0001	171.14.220.0001
100 / 4"	171.15.110.0001	171.15.210.0001	171.15.120.0001	171.15.220.0001
125	171.16.110.0001	171.16.210.0001	171.16.120.0001	171.16.220.0001
150	171.17.110.0001	171.17.210.0001	171.17.120.0001	171.17.220.0001

standard gasket NBR considered, other material on demand

t-pieces, short, DIN 11852 (for rubbing acc. DIN 11850 line 2) (311IN)

DN	304 polished Ident number	304 matt Ident number	316 L polished Ident number	316 L matt Ident number
25-32 / 1"	171.08.110.0020	171.08.210.0020	171.08.120.0020	171.08.220.0020
40 - 65	171.10.110.0020	171.10.210.0020	171.10.120.0020	171.10.220.0020
1½"-2½"	171.10.110.0020	171.10.210.0020	171.10.120.0020	171.10.220.0020
80 / 3"	171.14.110.0020	171.14.210.0020	171.14.120.0020	171.14.220.0020
100 / 4"	171.15.110.0020	171.15.210.0020	171.15.120.0020	171.15.220.0020
125	171.16.110.0020	171.16.210.0020	171.16.120.0020	171.16.220.0020
150	171.17.110.0020	171.17.210.0020	171.17.120.0020	171.17.220.0020

standard gasket NBR considered, other material on demand

t-pieces, short, DIN 11852 (for rubbing acc. DIN 11850 line 2) (311IN)

DN	304 polished Ident number	304 matt Ident number	316 L polished Ident number	316 L matt Ident number
25-32 / 1"	171.08.110.0002	171.08.210.0002	171.08.120.0002	171.08.220.0002
40 - 65	171.10.110.0002	171.10.210.0002	171.10.120.0002	171.10.220.0002
1½"-2½"	171.10.110.0002	171.10.210.0002	171.10.120.0002	171.10.220.0002
80 / 3"	171.14.110.0002	171.14.210.0002	171.14.120.0002	171.14.220.0002
100 / 4"	171.15.110.0002	171.15.210.0002	171.15.120.0002	171.15.220.0002
125	171.16.110.0002	171.16.210.0002	171.16.120.0002	171.16.220.0002
150	171.17.110.0002	171.17.210.0002	171.17.120.0002	171.17.220.0002

standard gasket NBR considered, other material on demand

t-pieces, short, DIN 11852 (for rubbing acc. DIN 11850 line 2) (311IN)

DN	316 L pol. gap 0,5 Ident number	316 L pol. gap 0,2 Ident number	316 L pol. gap 0,1 Ident number	316 L pol. gap 0,05 Ident number
25-32 / 1"	171.08.127.0024	171.08.127.0023	171.08.127.0022	171.08.127.0021
40 - 65	171.10.127.0024	171.10.127.0023	171.10.127.0022	171.10.127.0021
1½"-2½"	171.10.127.0024	171.10.127.0023	171.10.127.0022	171.10.127.0021
80 / 3"	171.14.127.0024	171.14.127.0023	171.14.127.0022	171.14.127.0021
100 / 4"	171.15.127.0024	171.15.127.0023	171.15.127.0022	171.15.127.0021
125	171.16.127.0024	171.16.127.0023	171.16.127.0022	171.16.127.0021
150	171.17.127.0024	171.17.127.0023	171.17.127.0022	171.17.127.0021

standard gasket NBR considered, other material on demand

passage filter, betw. flanges, DIN (702)

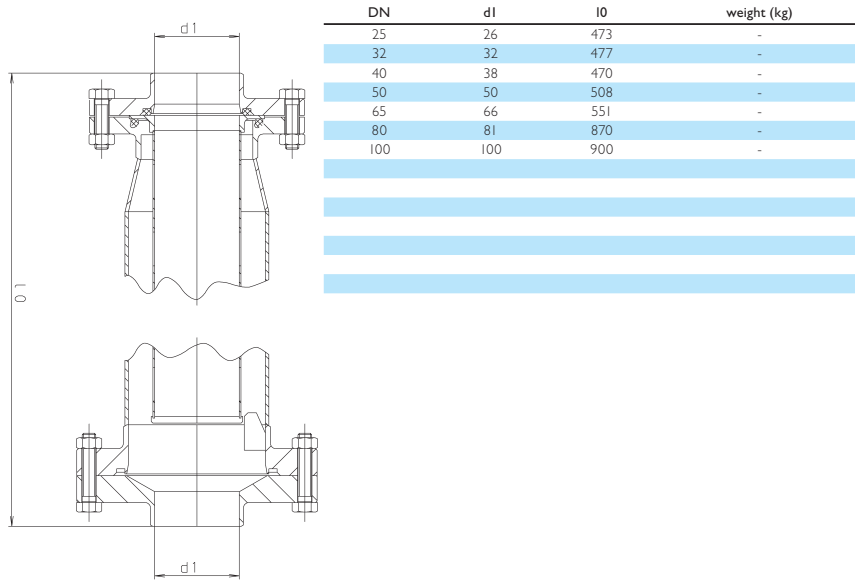

DN	d1	l0	weight (kg)
25	26	473	-
32	32	477	-
40	38	470	-
50	50	508	-
65	66	551	-
80	81	870	-
100	100	900	-

strainer for passage filter, 1.5 mm round hole perfor. (702A)

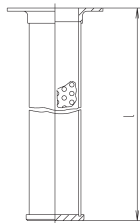

DN	l	weight (kg)
25 / 1"	405	0,200
32	398	0,300
40 / 1½"	398	0,400
50 / 2"	422	0,500
65 / 2½"	445	0,800
3"	750	1,300
80	750	1,400
100 / 4"	750	1,900

strainer for passage filter, with gauze inside (702B)

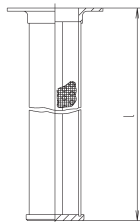

DN	l	weight (kg)
25 / 1"	405	0,200
32	398	0,300
40 / 1½"	398	0,400
50 / 2"	422	0,500
65 / 2½"	445	0,800
3"	750	1,300
80	750	1,400
100 / 4"	750	1,900

DN	304 polished		316 L polished	
	Ident number	Ident number	Ident number	Ident number
25	o 171.08.110.0018	o 171.08.210.0018	o 171.08.120.0018	o 171.08.220.0018
32	o 171.09.110.0018	o 171.09.210.0018	o 171.09.120.0018	o 171.09.220.0018
40	o 171.10.110.0018	o 171.10.210.0018	o 171.10.120.0018	o 171.10.220.0018
50	o 171.11.110.0018	o 171.11.210.0018	o 171.11.120.0018	o 171.11.220.0018
65	o 171.12.110.0018	o 171.12.210.0018	o 171.12.120.0018	o 171.12.220.0018
80	o 171.14.110.0018	o 171.14.210.0018	o 171.14.120.0018	o 171.14.220.0018
100	o 171.15.110.0018	o 171.15.210.0018	o 171.15.120.0018	o 171.15.220.0018

passage filter, betw. flanges, DIN (702)

standard gasket NBR considered, other material on demand

DN	304 polished		316 L polished	
	Ident number	Ident number	Ident number	Ident number
25 / 1"	o 171.08.110.0011	o 171.08.120.0011		
32	o 171.09.110.0011	o 171.09.120.0011		
40 / 1½"	o 171.10.110.0011	o 171.10.120.0011		
50 / 2"	o 171.11.110.0011	o 171.11.120.0011		
65 / 2½"	o 171.12.110.0011	o 171.12.120.0011		
3"	o 171.13.110.0011	o 171.13.120.0011		
80	o 171.14.110.0011	o 171.14.120.0011		
100 / 4"	o 171.15.110.0011	o 171.15.120.0011		

c-pieces, short, DIN 11852 (for tubing acc. DIN 11850 line 2) (S111N)

DN	304 polished		316 L polished	
	Ident number	Ident number	Ident number	Ident number
25 / 1"	o 171.08.110.0012	o 171.08.120.0012		
32	o 171.09.110.0012	o 171.09.120.0012		
40 / 1½"	o 171.10.110.0012	o 171.10.120.0012		
50 / 2"	o 171.11.110.0012	o 171.11.120.0012		
65 / 2½"	o 171.12.110.0012	o 171.12.120.0012		
3"	o 171.13.110.0012	o 171.13.120.0012		
80	o 171.14.110.0012	o 171.14.120.0012		
100 / 4"	o 171.15.110.0012	o 171.15.120.0012		

c-pieces, short, DIN 11852 (for tubing acc. DIN 11850 line 2) (S111N)

dirt collecting filter, weld ends, DIN (703)

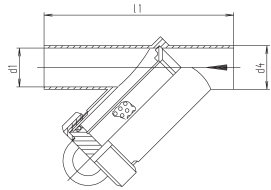

DN	d1	d4	l1	weight (kg)
25	26	30	157	-
32	32	36	157	-
40	38	42	167	-
50	50	54	175	-
65	66	70	231	-
80	81	85	271	-
100	100	104	291	-

dirt collecting filter, weld ends, inch OD (703Z)

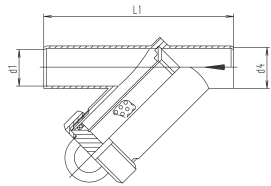

DN	d1	d4	l1	weight (kg)
1"	22.1	25.4	157	-
1½"	34.8	38.1	167	-
2"	47.5	50.8	175	-
2½"	60.2	63.5	231	-
3"	72.9	76.2	271	-
4"	97.4	101.6	291	-

dirt collecting filter, male/male, DIN (703)

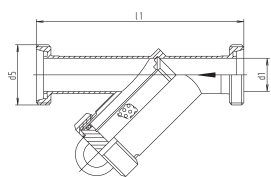

DN	d1	d5	l1	weight (kg)
25	26	52x1/6"	200	3,700
32	32	58x1/6"	200	4,350
40	38	65x1/6"	210	5,200
50	50	78x1/6"	220	7,000
65	66	95x1/6"	280	11,900
80	81	110x1/4"	320	-
100	100	130x1/4"	350	-

strainer for dirt collecting filter, 1.5 mm round hole perfor. (703A)

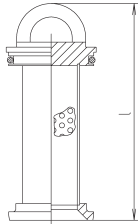

DN	l	weight (kg)
25 / 1"	128	0,200
32	129	0,300
40 / 1½"	141	0,400
50 / 2"	173	0,500
65 / 2½"	248	0,800
80	279	1,400
100	287	1,900

DN	304 polished Ident number	304 matt Ident number	316 L polished Ident number	316 L matt Ident number
25	○ 172.08.110.0020	○ 172.08.210.0020	○ 172.08.120.0020	○ 172.08.220.0020
32	○ 172.09.110.0020	○ 172.09.210.0020	○ 172.09.120.0020	○ 172.09.220.0020
40	○ 172.10.110.0020	○ 172.10.210.0020	○ 172.10.120.0020	○ 172.10.220.0020
50	○ 172.11.110.0020	○ 172.11.210.0020	○ 172.11.120.0020	○ 172.11.220.0020
65	○ 172.12.110.0020	○ 172.12.210.0020	○ 172.12.120.0020	○ 172.12.220.0020
80	○ 172.14.110.0020	○ 172.14.210.0020	○ 172.14.120.0020	○ 172.14.220.0020
100	○ 172.15.110.0020	○ 172.15.210.0020	○ 172.15.120.0020	○ 172.15.220.0020

standard gasket NBR considered, other material on demand

DN	304 polished Ident number	304 matt Ident number	316 L polished Ident number	316 L matt Ident number
1"	○ 172.08.110.0015	○ 172.08.210.0015	○ 172.08.120.0015	○ 172.08.220.0015
1½"	○ 172.10.110.0015	○ 172.10.210.0015	○ 172.10.120.0015	○ 172.10.220.0015
2"	○ 172.11.110.0015	○ 172.11.210.0015	○ 172.11.120.0015	○ 172.11.220.0015
2½"	○ 172.12.110.0015	○ 172.12.210.0015	○ 172.12.120.0015	○ 172.12.220.0015
3"	○ 172.13.110.0015	○ 172.13.210.0015	○ 172.13.120.0015	○ 172.13.220.0015
4"	○ 172.15.110.0015	○ 172.15.210.0015	○ 172.15.120.0015	○ 172.15.220.0015

standard gasket NBR considered, other material on demand

DN	304 polished Ident number	304 matt Ident number	316 L polished Ident number	316 L matt Ident number
25	● 172.08.110.0000	○ 172.08.210.0000	○ 172.08.120.0000	○ 172.08.220.0000
32	● 172.09.110.0000	○ 172.09.210.0000	○ 172.09.120.0000	○ 172.09.220.0000
40	● 172.10.110.0000	○ 172.10.210.0000	○ 172.10.120.0000	○ 172.10.220.0000
50	● 172.11.110.0000	○ 172.11.210.0000	○ 172.11.120.0000	○ 172.11.220.0000
65	● 172.12.110.0000	○ 172.12.210.0000	○ 172.12.120.0000	○ 172.12.220.0000
80	○ 172.14.110.0000	○ 172.14.210.0000	○ 172.14.120.0000	○ 172.14.220.0000
100	○ 172.15.110.0000	○ 172.15.210.0000	○ 172.15.120.0000	○ 172.15.220.0000

standard gasket NBR considered, other material on demand

DN	304 polished Ident number	304 matt Ident number	316 L polished Ident number	316 L matt Ident number
25 / 1"	○ 172.08.110.0001	○ 172.08.210.0001	○ 172.08.120.0001	○ 172.08.220.0001
32	○ 172.09.110.0001	○ 172.09.210.0001	○ 172.09.120.0001	○ 172.09.220.0001
40 / 1½"	○ 172.10.110.0001	○ 172.10.210.0001	○ 172.10.120.0001	○ 172.10.220.0001
50 / 2"	○ 172.11.110.0001	○ 172.11.210.0001	○ 172.11.120.0001	○ 172.11.220.0001
65 / 2½"	○ 172.12.110.0001	○ 172.12.210.0001	○ 172.12.120.0001	○ 172.12.220.0001
80	○ 172.14.110.0001	○ 172.14.210.0001	○ 172.14.120.0001	○ 172.14.220.0001
100	○ 172.15.110.0001	○ 172.15.210.0001	○ 172.15.120.0001	○ 172.15.220.0001

standard gasket NBR considered, other material on demand

strainer for dirt collecting filter, gauze (703B)

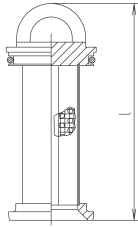

DN	l	weight (kg)
25 / 1"	128	0,240
32	129	0,340
40 / 1½"	141	0,440
50 / 2"	173	0,550
65 / 2½"	248	0,860
80 / 3"	279	1,480
100 / 4"	287	1,990

t-pieces, short, DIN 11852 (for tubing acc. DIN 11850 line 2) (311IN)

DN	304 polished Ident number	304 matt Ident number	316 L polished Ident number	316 L matt Ident number
25 / 1"	o 172.08.110.0002	o 172.08.210.0002	o 172.08.120.0002	o 172.08.220.0002
32	o 172.09.110.0002	o 172.09.210.0002	o 172.09.120.0002	o 172.09.220.0002
40 / 1½"	o 172.10.110.0002	o 172.10.210.0002	o 172.10.120.0002	o 172.10.220.0002
50 / 2"	o 172.11.110.0002	o 172.11.210.0002	o 172.11.120.0002	o 172.11.220.0002
65 / 2½"	o 172.12.110.0002	o 172.12.210.0002	o 172.12.120.0002	o 172.12.220.0002
80 / 3"	o 172.14.110.0002	o 172.14.210.0002	o 172.14.120.0002	o 172.14.220.0002
100 / 4"	o 172.15.110.0002	o 172.15.210.0002	o 172.15.120.0002	o 172.15.220.0002

standard gasket NBR considered, other material on demand